

Miele

NAVITRONIC

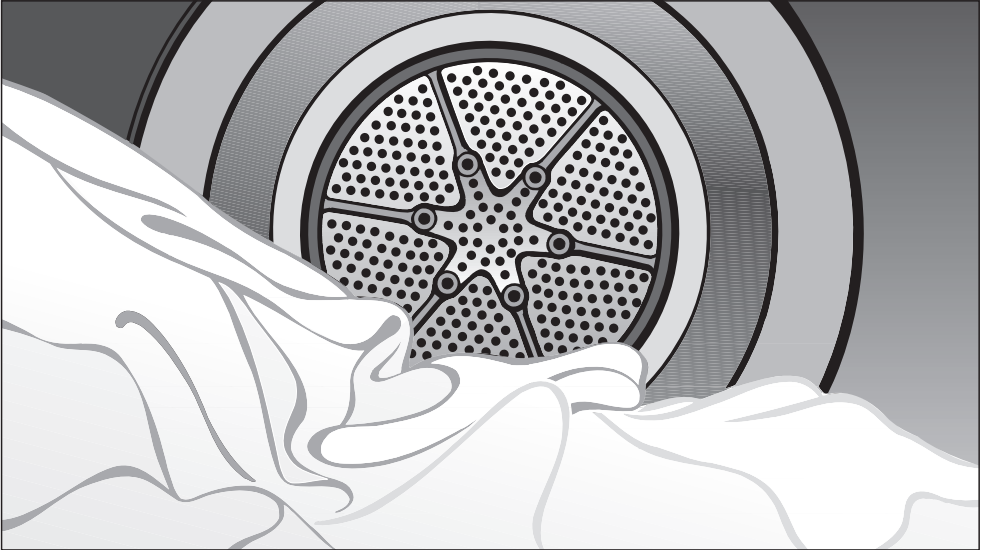

Operating instructions for condenser tumble dryer T 4882 C

It is **essential** to read these operating instructions before installing or using the machine to avoid the risk of accidents or damage to the machine.



M.-Nr. 05 986 620

Caring for the environment

Disposal of the packing material

The transport and protective packing has been selected from materials which are environmentally friendly for disposal and can normally be recycled.

Ensure that any plastic wrappings, bags etc. are disposed of safely and kept out of the reach of babies and young children. Danger of suffocation!

Rather than just throwing these materials away, please ensure they are offered for recycling.

Disposal of your old appliance

Old appliances contain materials which can be reclaimed or recycled. Please contact your dealer, your local waste collection centre or scrap merchant about potential recycling schemes.

Ensure that the machine presents no danger to children while being stored for disposal.

 Before throwing an old appliance away unplug it and render the plug useless. Cut off the cable directly behind the appliance to prevent misuse. This should be done by a competent person.

Energy saving tips

- Make sure that your laundry is thoroughly spun before drying.

The higher the spin, the greater the savings that can be made in energy and time during drying.

- Load according to the optimum amount of laundry recommended for the programme being used (see Programme chart).

Underloading is uneconomical. Overloading gives a poorer quality of drying and may cause unnecessary creasing.

- To save energy and time:
 - make sure the room in which the dryer is located is well ventilated.
 - Make sure the fluff filters are clean before using the dryer.

Caring for the environment	2
Disposal of the packing material	2
Disposal of your old appliance	2
Energy saving tips	2
Warning and Safety instructions	6
Operating the tumble dryer	9
Control panel	9
Displays	10
Before using for the first time	12
Notes on laundry care	13
Wash care symbols	13
Tips on drying	13
How to dry correctly	14
Brief instructions	14
Favourite programmes	17
Selecting/changing a favourite	17
Saving a favourite programme.	19
Extras	20
Short.	20
Low temp.	20
Timer	21
Programme chart	22
Changing the programme sequence	25
To cancel a programme.	25
To interrupt a programme	25
Adding or removing laundry after a programme has started	25
Electronic programme locking	26

Contents

Cleaning and care	27
Emptying the condensed water container	27
Cleaning the fluff filters	28
Cleaning them whilst dry	28
Cleaning them with water	29
Cleaning the tumble dryer	29
Cleaning the condenser unit	30
Removing the condenser unit	30
Checking the condenser unit	31
Cleaning the condenser unit	31
Replacing the condenser unit	32
Problem solving guide	33
Fault messages in the display	33
Other problems	35
Changing the lamp	38
After Sales service	39
Future updates (PC)	39
Optional accessories	39
Installation	40
Front view	40
Installation site	41
Transporting the machine to its installation site	41
Building under a continuous worktop / in a row of kitchen units	41
Replacing the lid	41
Aligning the machine	42
Room in which the dryer is located	42
Washer - dryer stack	42
Before moving the machine again (e.g. when moving house)	42
External condensed water outlet	43
Pulling out the drain hose	43
Connection to a sink drain outlet	44
If you no longer wish to use an external condensed water outlet:	44

Electrical connection	45
Electrical connection U.K.	45
Consumption data	47
Technical data	48
Settings menu ▮	50
Open the <i>Settings</i> menu	50
Language ▮	50
Time of day	51
Drying levels	52
Extending the cooling down time	52
Airways indicator	53
Anti-crease	53
Lock	54
Buzzer	56
Keypad tones	56
Display contrast	57
Stand-by	58
To close the <i>Settings</i> menu	58

Warning and Safety instructions

Read the operating instructions carefully before using this appliance for the first time. They contain important information about the safety, use and maintenance of the appliance. This way you will avoid the risk of accidents and damage to the appliance.

Keep these operating instructions in a safe place and ensure that new users are familiar with the content. Pass them on to any future owner of the machine.

Correct use

The tumble dryer is only intended for drying fabrics which have been washed in a water solution, marked on the manufacturer's wash care label as being suitable for tumble drying.

"Dry Cleaning Kits" for freshening up garments in a tumble dryer are increasingly available on the market. If using, do so at your own risk and follow the instructions provided on the packaging.

Any other applications may be dangerous. The manufacturer is not liable for damage resulting from improper use or operation.

This appliance is not a toy! To avoid the risk of injury, do not allow children to play on or near it, or to play with the controls. Supervise its use by the elderly or infirm.

Technical safety

Before setting up the machine check it for any externally visible damage. Do not install or use a damaged machine.

Before connecting the machine, ensure that the connection data on the data plate (fusing, voltage and frequency) matches the mains electricity supply. If in any doubt, consult a qualified electrician.

The electrical safety of this machine can only be guaranteed when continuity is complete between the appliance and an effective earthing system which complies with local and national regulations. It is most important that this basic safety requirement is regularly tested, and where there is any doubt the household wiring system should be inspected by a qualified electrician. The manufacturer cannot be held liable for the consequences of an inadequate earthing system (e.g. electric shock).

Do not connect the machine to the mains electricity supply by an extension lead. Extension leads do not guarantee the required safety of the machine (e.g. danger or overheating).

The machine is built in accordance with current safety requirements. Unauthorised repairs could result in unforeseen dangers for the user, for which the manufacturer cannot accept liability. Repairs should only be undertaken by a Miele approved technician.

Ensure current is not supplied to the appliance while maintenance or repair work is being carried out.

Faulty components must only be exchanged for Miele original spare parts. Only when these parts are fitted can the safety standards of the machine be guaranteed.

Warning and Safety instructions

■ If the connection cable is faulty it must only be replaced by a Miele approved service technician to protect the user from danger.

■ In the event of a fault or for cleaning purposes, the machine is only completely isolated from the electricity supply when:

- it is switched off at the wall socket and the plug is withdrawn, or
- it is switched off at the mains, or
- the mains fuse is withdrawn.

Operation

■ This equipment is not designed for maritime use or for use in mobile installations such as caravans, aircraft etc. However it may be suitable for such usage subject to a risk assessment of the installation being carried out by a suitably qualified engineer.

■ The dryer must not be used without the fluff filters in place or if the fluff filters are damaged in any way.

■ The fluff filters must be thoroughly dried after cleaning. If they are still damp or wet when replaced there is a risk of faults occurring when the machine is used.

■ The dryer must not be used without the condenser unit in place.

■ Do not install the machine in a room where the temperature may drop down to or below freezing. At very cold temperatures the machine may be difficult to start.

There is a risk of damage if the condensed water is allowed to freeze in

the pump, hoses and / or condensed water container.

■ If the water is drained externally through the drain hose instead of being collected in the condensed water container, make sure the drain hose is securely attached if you hang it in a sink or basin to avoid the hose slipping and the water causing damage.

■ Condensed water is not drinking water. It can cause health problems in both people and animals.

■ Always keep the area around the machine free of dust and fluff. Dust drawn into the machine can, over time, cause blockages in the condenser unit.

Warning and Safety instructions

Always close the door after use. This way you will avoid the danger of:

- children climbing onto or into the dryer or hiding things in it.
- pets or other small animals climbing into it.

Do not let anyone sit or lean on the door, as this can cause the machine to start tipping up.

There is danger of fire with fabrics which:

- contain a large proportion of rubber, foam rubber or rubber like materials.
- have been treated with inflammable cleaning agents.
- have been splashed with hair lacquer, hair spray, nail varnish remover or similar substances.
- which contain padding or fillings (e.g. pillows, jackets). If these were damaged the filling could leak out with the risk of igniting in the dryer.
- are soiled with oil or grease.

Using accessories

Accessory parts may only be fitted when expressly approved by Miele. If other parts are used, guarantee, performance and product liability claims may be invalidated.

In countries where there are areas which may be subject to infestation by cockroaches or other vermin, pay particular attention to keeping the appliance and its surroundings in a clean condition at all times. Any damage which may be caused by cockroaches or other vermin will not be covered by the appliance guarantee.

Control panel

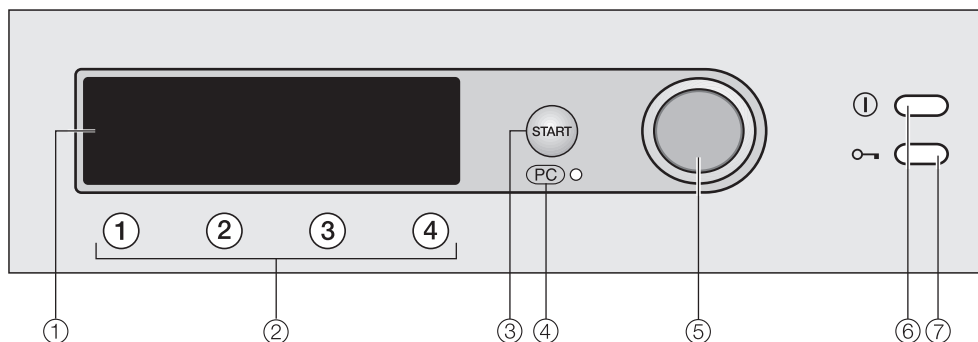

① Display

See the following pages for more information.

② Short cut buttons

For selecting an individual programme quickly. These buttons can be programmed to select your own favourite drying programmes.

③ Start button

④ Optical interface (PC)

This is used by service technicians to run diagnostic checks on your machine and can also be used to update programming data in the future.

⑤ Multi-function selector

This is used to select menu options (by turning it) and to confirm your selection (by pressing it).

⑥ On/Off button ①

To switch the dryer on or off.

⑦ Door button

To open the door

Operating the tumble dryer

Displays

Entry menu

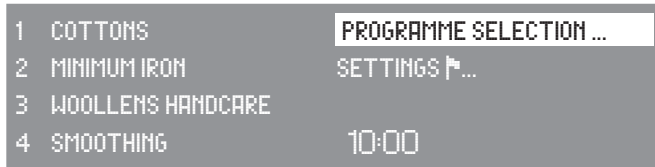

When the machine is switched on, the entry menu (with factory default settings) appears and *Programme Selection* is highlighted.

Multi-function selector

Turning the multi-function selector moves the highlighting to the next menu option.

Pressing the multi-function selector selects the highlighted menu option.

Short cut buttons

Pressing a short cut button selects one of the four favourite programmes, which appear on the left of the display. You can customise the favourite programmes to suit your own requirements.

The short cut buttons have different functions in the other menus. Where this is the case, an arrow ▼ will appear in the display above the short cut button, together with a description of its function .

Programme selection

There are two ways of selecting a programme:

- Option 1: Select the *Programme Selection* menu in the display and confirm your selection by pressing the multi-function selector.
- Option 2: Press short cut button ①, ②, ③, or ④. This will automatically take you into the main menu of that programme.

Operating the tumble dryer

Programme Selection menu



You can use the multi-function selector to select any programme. The highlighting will move up or down depending on the direction the multi-function selector is turned in. The ▲ ▼ arrows on the right of the display indicate the turning direction and further options. Pressing the multi-function selector takes you to the main menu of the programme selected.

Drying programme main menu



- Turn the multi-function selector to highlight either the "Drying level" or the "Programme".
- Pressing the multi-function selector selects the highlighted option and opens the relevant sub-menu.
- The sub-menus *Extras*, *Timer* and *Save* can be opened by pressing the short cut button directly below them. You return to the entry menu by pressing short cut button ④ below *Back*.

Alternatively, you can also highlight and confirm all options by just using the multi-function selector.

Settings menu

The Settings menu is used to alter the tumble dryer's electronics to suit different requirements. See "Settings menu" for more details.

Operating the tumble dryer

Before using for the first time

When the tumble dryer is switched on for the first time, the welcome screen will appear.

Welcome screen



The welcome screen will not appear again after you have entered the time of day, and run an initial programme lasting longer than one hour.

The display will then switch to show the time of day.



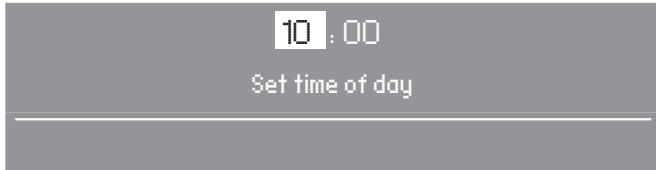









Setting the time of day



- Set the hour with the multi-function selector and confirm this setting. Now set the minutes. Once this has been confirmed, the time of day is saved in memory and the display goes back to the entry menu.

Wash care symbols

Before drying check the drying symbol on the wash care label.

-  Dry at normal temperature
-  Dry at a low temperature
-  Do not tumble dry
-      Cottons
-     . Minimum iron/Delicates

- For delicates and fabrics with the following wash care label  you should also select the *low temperature* extra option.
- Cottons, linens and minimum iron items should be dried using the appropriate programme for the degree of dryness required.

Tips on drying

Always observe the maximum recommended loads given in the “Programme chart”. Never overload the drum. Overloading can cause unnecessary wear and tear to the laundry, give a disappointing drying result and cause more creasing.

Do not put soaking wet items into the tumble dryer. Spin them thoroughly after washing for at least 30 seconds.

- Woollens and wool blends tend to become matted and shrink if dried in a tumble dryer. They can, however, be partially dried using the *Woollens hand care* programme.

- Down-filled garments have linings which have a tendency to shrink, depending on the quality of the item. These garments can be partially dried using the *Smoothing* programme.
- Pure linen should only be machine dried if specified as suitable by the manufacturer on the wash care label, as the surface of the fabric may otherwise become rough. These garments can be partially dried using the *Smoothing* programme.
- Loopknit garments (e.g. T-shirts and underwear) tend to shrink depending on their quality. Therefore: to prevent further shrinkage do not over-dry these textiles. When purchasing these garments it is advisable to take their shrinkage properties into account, and select items one or two sizes larger.
- Minimum iron fabrics and 100% cotton shirts or blouses tend to crease more the greater the load. This is especially true of very fine weaves, such as shirts or blouses. Reduce the load or use the *Shirts* programme.
- Starched laundry can be dried in the tumble dryer. To achieve the usual finish, double the amount of starch should be used.
- New dark coloured garments should be dried separately from light coloured garments to avoid the danger of colours running.

How to dry correctly

Brief instructions

The heading numbered (1, 2, 3 ...) show the operating sequence and can be used as a brief guide to using your machine.

1 Sort the laundry

Separate out the washed laundry and sort it according to:

- ... the drying level required
 - ... the type of fibre or weave
 - ... size
 - ... the moisture content after spinning.
- In this way an even drying result will be achieved.

⚠ Make sure that objects e.g. detergent dispensing balls have been removed from the laundry. They could melt, and cause damage to the dryer or the laundry.

- Check seams and stitching to ensure that padding and linings are intact.
- Fasten duvet covers and pillow cases to prevent small items from being trapped inside them.
- Fasten zips, hooks and eyes etc.
- Tie fabric belts and apron strings.
- Sew in or remove underwiring from bras.

2 Turn on the tumble dryer

- Switch the dryer on by pressing the ON/OFF button ①.

The tumble dryer may be switched on after loading, saving energy as the light will not come on.

3 Load the tumble dryer

- Press the  button to open the door.
- Load the laundry loosely into the drum.

Do not overload the drum. See the "Programme chart" for recommended loads for each programme. Overloading can cause unnecessary wear and tear to the laundry and give a disappointing drying result.

- Before closing the door make sure the fluff filter is correctly positioned in the door.

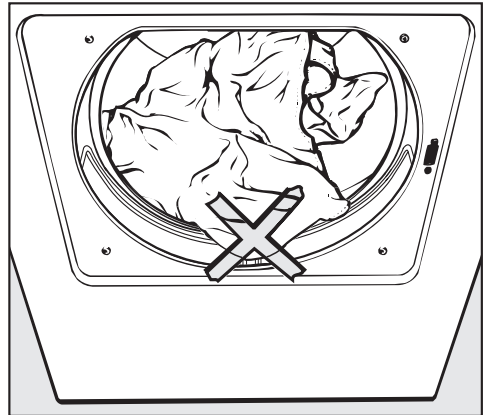

Check the laundry is right inside the drum so that it cannot get trapped or damaged when the door is shut.

- Shut the door either with a gentle swing, or lean against it and push it shut.

4 Select a programme

- You can select a programme either by:
 - using the appropriate short cut button to select one of the four most frequently used programmes ('favourites'), or
 - by going into the *Programme Selection* menu.
- If required, you can then select any *Extras* and use the *Timer* from the relevant sub-menu.

The *Start* button will flash as soon as a programme can be started.



5 Start the programme

- Press the *Start* button.

The *Start* button will light up.

- *Programme start* will appear in the display, followed by *drying* and the programme duration.
- With sensor drying programmes the drying level reached, e.g. *Machine iron*, *Hand iron* , etc. will show in the display.

Once drying is in progress, you can press short cut:

- Button  *Timer* to call up the current time of day and the estimated end time of the programme.
- Button  *Save* to save the current programme as a favourite.
- Button  *Cancel* to cancel the current programme.

Estimated time remaining

When a programme is selected the estimated drying time will appear in the display. Please be aware that it is only an estimate!

The following factors all affect the estimated time remaining: Residual moisture content after spinning; type of fabric; size of load; room temperature; fluctuations in power supply.

The electronics continually assess conditions in the machine and adjust the estimated time remaining for a more accurate reading. Because of this the time displayed can alter during the course of a programme.

In the same way, the *Woollens handcare* and *Smoothing* programmes can finish earlier than expected if a certain temperature is reached. This can happen with particularly fine fabrics or if items were dry beforehand.

How to dry correctly

Before the end of a programme

There is a cooling down phase at the end of the drying sequence: *Cooling down* will appear in the display. The programme will not finish until the cooling down phase has been completed.

There is no cooling down phase at the end of the following programmes:
Woollens handcare, *Smoothing*.

At the end of a programme

Anti-crease and *Finish* will appear in the display to indicate that the programme has finished. The buzzer will sound.

During the Anti-crease phase (factory default setting) the drum will continue to rotate at intervals to prevent laundry creasing if you do not wish to remove it immediately. The anti-crease phase lasts for 1 hour.

6 Remove the laundry

- Press the  button to open the door.
- Remove the laundry.

Make sure that the drum is empty. If items are left in the dryer, they could be damaged by overdrying when the dryer is next used.

If the appliance is switched on at the mains and the door is opened, the drum lighting will come on. It will go out a few minutes later to save energy.

- Press the  button to switch the dryer off.
- Clean the fluff filters.
- Close the door.

- Empty the condensed water container (unless the dryer is connected for external drainage).

You can programme the short cut buttons to call up the four drying programmes you use most frequently.

Selecting/changing a favourite

- Switch the machine on.

Entry menu



- Press short cut button ①.

Main menu



- Confirm your selection of the part you want to change by pressing the multi-function selector once.

Depending on the option selected, one of the following will be displayed:

– Programme selection



- Use the multi-function selector to select the programme you want and confirm your selection. The main menu will appear.

Favourite programmes

Important: If you do not make a selection in the sub-menu within approx. 20 seconds, the display will revert to the main menu.

– **Cottons, Minimum iron, Automatic programmes**



- Use the multi-function selector to select the drying level you want and confirm your selection.
- Any of the drying levels can be selected for the *Cottons* programme. A more limited range is available when using the *Minimum iron* and *Automatic* programmes.

– **Warm air, Cool air programmes**



- Use the multi-function selector to select the duration you want and confirm your selection.
- 15 to 30 minutes in 5 minute stages
- 30 mins to 2 hrs in 10 minute stages

The programme end time for the duration selected will also appear.

– **Woollens handcare, Smoothing, Denim, Shirts, Outer wear programmes**



Extras, drying level or programme duration cannot be selected or changed for this programme.

Selecting Extras

- Press short cut button ① *Extras*.



- Use the multi-function selector to select the Extra you want and confirm your selection. The main menu will reappear.

Saving a favourite programme

All the settings you have selected are now shown in the main menu.

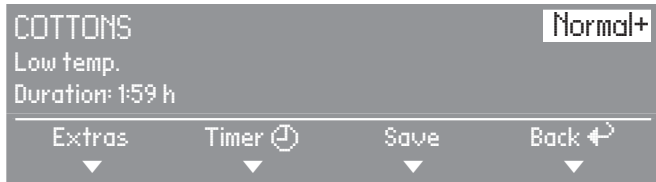

- Press short cut button ③ *Save*.

Select a short cut button



- Use the multi-function selector to select the number you want and confirm your selection. Your settings have now been saved as a favourite programme and will appear in the entry menu.

Repeat the procedure if you want to customise additional favourite programmes, and save them to short cut buttons which have not yet been used.

Extras

Open the Extras sub-menu



- Press short cut button  *Extras*. This opens the *Extras* sub-menu.

Selecting Extras



- Use the multi-function selector to select either *Short* or *Low temp.* and confirm your selection.

An *Extra* which has already been selected

- will be shown with a tick beside it.
- can be de-selected by highlighting it and then confirming your selection.

Short

For drying fabrics which can withstand higher temperatures. Do not use on minimum iron or delicate fabrics.

- The programme duration is shorter.

Low temp.

For drying delicate fabrics at a lower temperature.

- For all delicate or minimum iron fabrics with the  symbol on the care label (e.g. acrylic garments).
- The programme duration is longer.

You can use the timer to set the end time of a programme, allowing you to make use of night-time economy electricity rates, for example. The programme start can be delayed to start automatically in 30 minute intervals up to a maximum of 24 hours.

To open the Timer sub-menu



- Press short cut button ② *Timer*. This opens the *Timer* sub-menu.

To select the end time of a programme

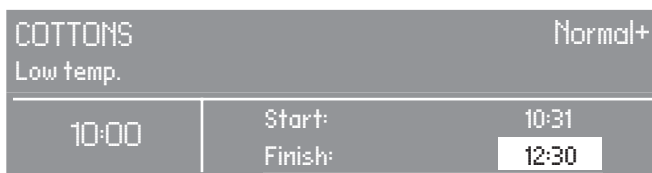

- Use the multi-function selector to select the programme end time and confirm your selection.

The programme end time will be adjusted to the next full or half hour. Once the end time has been entered, the start time of the programme will also appear.

To start the timer





- Press the *Start* button. The timer will count down in minutes until the start of the programme.

If the time until the programme start is more than one hour, the drum will turn for a few seconds every hour (to reduce creasing in garments). You can still add laundry by pressing the  button to open the door. After adding or removing items: Close the door and press the *Start* button.

To cancel the timer

- Press short cut button ④ once and then once again.

Programme chart

Cottons Extra dry		Max. load: 5 kg*
Fabric type	Multi-layered fabrics, which would not be thoroughly dried using the Normal + programme.	
Notes	Do not dry jersey fabrics in the <i>Extra dry</i> programme as they have a tendency to shrink.	
Extras	Short or Low Temp.	
Cottons Normal +		Max. load: 5 kg*
Fabric type	Single and multi-layered fabrics, e.g. mixed load of cotton fabrics e.g. towelling, jerseywear, underwear.	
Extras	Short or Low Temp.	
Cottons Normal **		Max. load: 5 kg*
Fabric type	Load of similar cotton items, e.g. underwear, flannelette bed linen, towelling.	
Notes	If laundry is still too damp, then finish drying using the Warm air programme and use the <i>Normal +</i> programme next time.	
Extras	Short or Low Temp.	
Cottons Hand iron 		Max. load: 5 kg*
Fabric type	Cottons and linen fabrics, e.g. table linen, bedlinen, starched laundry etc.	
Extras	Short or Low Temp.	
Cottons Hand iron   **		Max. load: 5 kg*
Fabric type	Cottons and linen fabrics, e.g. table linen, bedlinen, starched laundry etc.	
Notes	If laundry is still too damp, then select <i>Hand iron </i> in the future.	
Extras	Short or Low Temp.	
Cottons Machine iron		Max. load: 5 kg*
Fabric type	Cotton and linen fabrics, including starched laundry for machine ironing.	
Notes	The laundry should be rolled up to prevent it from drying out before it can be ironed.	
Extras	Short or Low Temp.	

* Weight of dry laundry

** Note for test institutes:

This programme setting without Extras should be used when testing according to EN 61121 Standard.

Programme chart

Minimum iron Normal +		Max. load: 2.5 kg*
Fabric type	Minimum iron items made of synthetic or blended fabrics which are not dried adequately in the Normal programme.	
Extras	Short or Low Temp.	
Minimum iron Normal **		Max. load: 2.5 kg*
Fabric type	Minimum iron shirts, blouses, skirts, table cloths etc. made of mixed fibres, e.g. cottons / synthetics. Minimum iron cottons.	
Extras	Short or Low Temp.	
Minimum iron - Hand iron Δ		Max. load: 2.5 kg*
Fabric type	Minimum iron blended fabrics such as cottons/synthetics e.g. shirts, blouses, skirts and table cloths which are still to be hand ironed.	
Notes	– Spin minimum iron fabrics for at least 30 seconds in the washing machine before drying. For extra special care of delicate fabrics and to reduce creasing even more, reduce the load to 1 kg*.	
Extras	Short or Low Temp.	
Woollens handcare		Max. load: 2 kg*
Fabric type	Woollen fabrics	
Notes	<ul style="list-style-type: none"> – To refresh and fluff up woollen garments quickly. Woollen fabrics are not dried completely by this programme. – Remove garments immediately at the end of the programme. Do not repeat. 	

* Weight of dry laundry

** Note for test institutes:

This programme setting without Extras should be used when testing according to EN 61121 Standard.

Programme chart

Smoothing		Max. load: 2.5 kg*
Fabric type	<ul style="list-style-type: none"> – Cottons and linen fabrics. – Minimum iron items made of mixed fibres, e.g. cottons/synthetics, such as cotton trousers, jackets, shirts. 	
Notes	<ul style="list-style-type: none"> – Smooths out creasing caused during the spin cycle in the washing machine. – Fabrics are not completely dried in this programme. Remove garments immediately at the end of the programme and place on a line or hangers to dry. 	
Warm air		Max. load: 5 kg*
Fabric type	<ul style="list-style-type: none"> – Multi-layered fabrics whose layers have different drying characteristics, e.g. jackets, pillows. – For drying individual items, e.g. bath towels, bathing costumes, tea-towels. 	
Notes	Do not select the longest drying time to start with. Check the items as you are drying them to find the optimum time.	
Extra	Low temp.	
Cool air		Max. load: 5 kg*
Fabric type	Any item which only needs airing.	
Denim		Max. load: 2 kg*
Fabric type	Denim fabrics, e.g. jeans, jackets, skirts, shirts.	
Shirts		Max. load: 1.5 kg*
Fabric type	Shirts and blouses	
Outer wear		Max. load: 2 kg*
Fabric type	Outer wear which is suitable for drying in a tumble dryer.	
Automatic Normal		Max. load: 3 kg*
Fabric type	Mixed load of cotton and minimum iron fabrics.	
Automatic Hand iron Δ		Max. load: 3 kg*
Fabric type	Mixed load of cotton and minimum iron fabrics, which are still to be hand ironed.	

* Weight of dry laundry

Changing the programme sequence

To cancel a programme

- Press short cut button ④ *Cancel*.

The items will be cooled down, depending how long they have been dried for and the temperature reached.

Finish will appear when you press short cut button ④ *Cancel* again.

- Switch the tumble dryer off by pressing the ① button.
- Switch the tumble dryer on again by pressing the ① button.
- Select a different programme.

To continue drying

- Press the *Start* button.

To interrupt a programme

- Switch the tumble dryer off by pressing the ① button.

To continue drying

- Switch the tumble dryer on again by pressing the ① button.

Adding or removing laundry after a programme has started

- Press the  button.
- Open the door.

 Do not touch the back of the drum when adding or removing items. The drum could be very hot - danger of burning.

- Add or remove items.
- Close the door.

To continue drying

- Press the *Start* button.

The time left shown in the display may now vary from the actual drying time.

Electronic programme locking

Programme locking prevents the short cut buttons or the multi-function selector being used while drying is in progress.

The door is not locked and can be opened at any time.

To activate programme locking

- Once the programme has begun, press and hold the *Start* button until the following appears in the display:

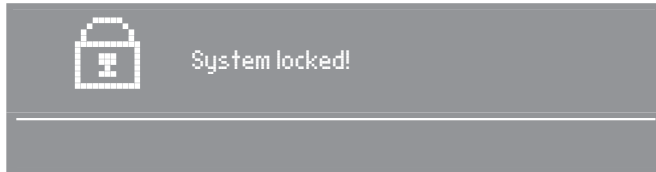

Now no more alterations can be made to the programme.

Programme locking is deactivated automatically at the end of the programme or by pressing button .

To deactivate programme locking

- Press and hold the *Start* button until the following appears in the display:

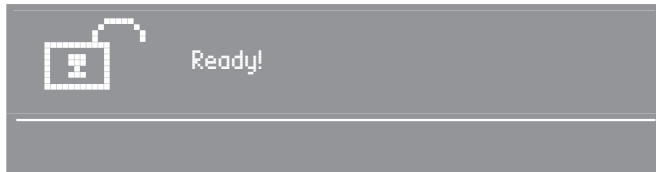

Emptying the condensed water container

The condensed water will be collected in the condensed water container unless the appliance has been fitted with a drain hose (see installation).

Empty the condensed water container after every drying programme.

The drying programme will be interrupted if the maximum level of the condensed water container is reached. A message will appear in the display.

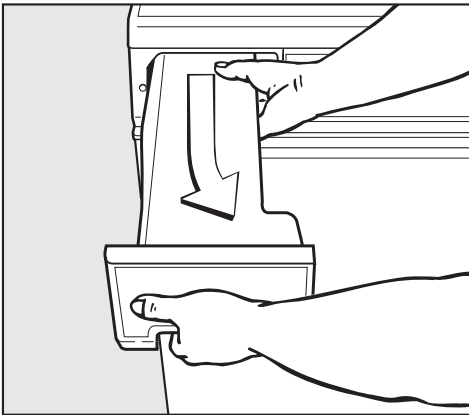

- Holding the container firmly in both hands, as shown, pull it out slightly towards the right-hand side.
- Hold the container in a horizontal position when carrying it.

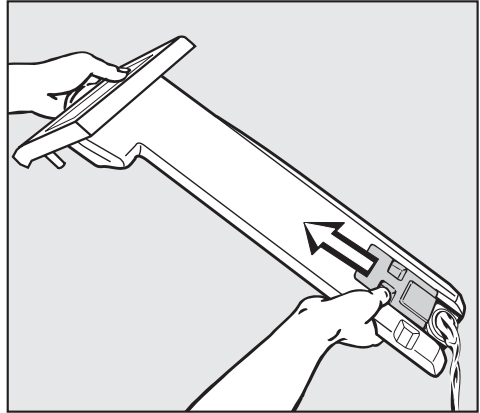

- Open the shutter and empty out the water.
- To replace the container, hold it at a slight angle (as when removing it) and push it in gently until you feel it click into position.
- To remove the message from the display, switch the dryer off and then on again.

Condensed water should not be consumed. It could lead to health problems for people and animals.

Condensed water can be put to household use (e.g. used in a steam iron or humidifier). To ensure that any residual particles of fluff in the condensed water are removed before use, pass it through a fine sieve or paper filter first.

Cleaning and care

Cleaning the fluff filters

The fluff which is created by the drying process is collected by the fluff filters in the door and the door opening. Clean the filters after **each** drying programme.

Cleaning them whilst dry

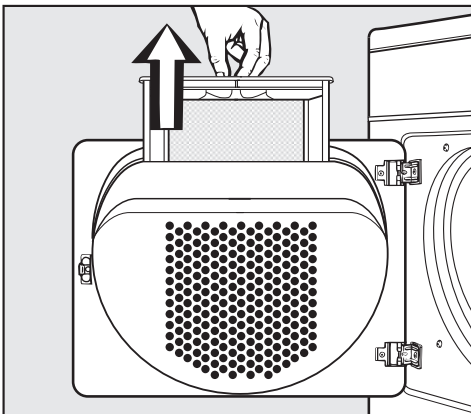

- Open the door and pull the fluff filter out of the door as illustrated.

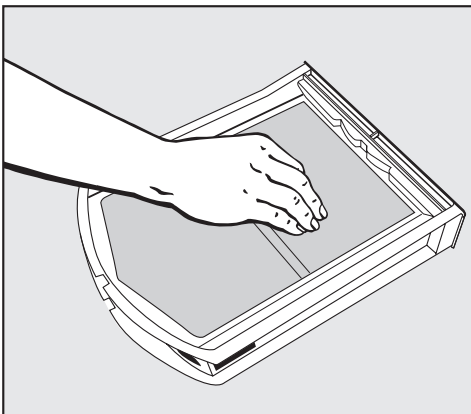

- Use your fingers to remove the fluff from the surface of the filter.

- Remove any fluff from the hollow part of the door holder. A cleaning brush is available as an optional extra from your Miele dealer or the Miele Spare Parts Department.

Tip: You can also use a vacuum cleaner.

- Once clean, push the filter back into the door holder until it clicks into position. Ensure it is facing the correct way.

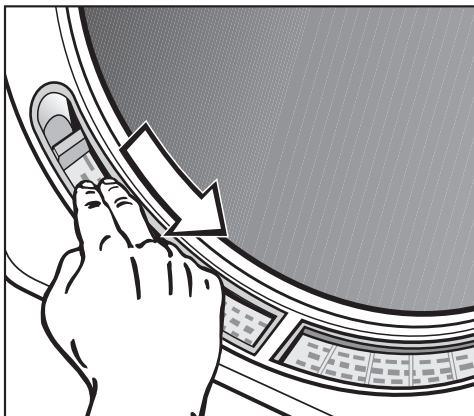

- Use your fingers to remove the fluff from the two fluff filters in the door opening.
- Close the door.

Cleaning them with water

If there is a great deal of compacted fluff on any of the filters, they can be removed and cleaned under hot running water.

- To remove the fluff filter from the door holder see previous page.

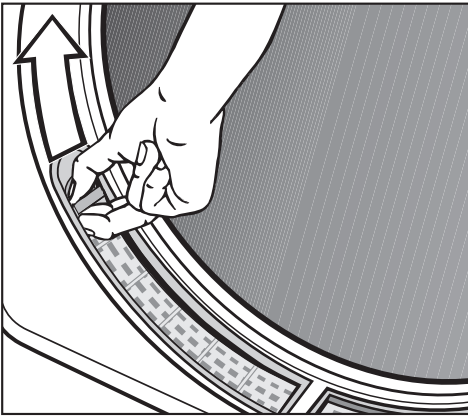

- Grip the holder and push the filter in the door opening upwards in the direction of the arrow to remove it. Do the same on the opposite filter.
- Rinse the filters under hot, running water.
- Then shake the filters until no more water droplets are visible.
- Dry the filters thoroughly with care.

 Do not replace them if they are damp or wet. Damp or wet filters could cause operational faults.

- Push the large filter back into the door holder until it clicks into position. Ensure it is facing the correct way.

- Place the filters back in the door opening (the left and right filters are identical) with the finger holders facing upwards. See illustration.

Cleaning the tumble dryer

Disconnect the machine from the mains electricity supply.

- Clean the housing and control panel with a slightly damp cloth and a mild detergent or soapy water.
- The drum and other stainless steel parts can be cleaned with a suitable proprietary stainless steel cleaner following the manufacturer's instructions.

Do not use solvents, abrasive cleaners, glass cleaners or all-purpose cleaners. These could damage plastic surfaces and other parts. The machine must never be hosed down.

- Dry all parts with a soft cloth.
- A microfibre E-Cloth is available from the Miele UK Spare Parts Department which is suitable for cleaning surfaces such as stainless steel, glass, plastic and chrome without the use of chemicals. It can be washed 300 times.

Cleaning and care

Cleaning the condenser unit

Detergent residue, hair and fine fluff from the dryer can get through the fluff filters and block the condenser unit.

Dust from the room in which the dryer is installed can also get into the condenser unit and cause a blockage.

Check the condenser unit at least twice a year. If the dryer is used frequently then clean the condenser unit after approx. 100 drying cycles.

Removing the condenser unit

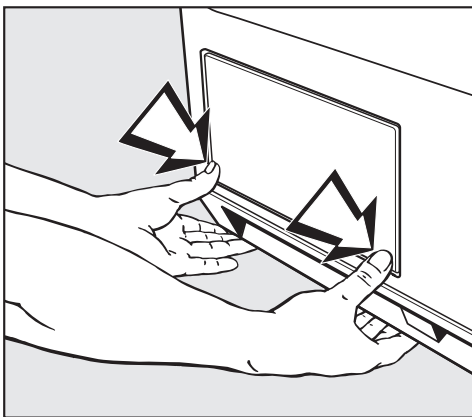

- Open the service panel by pressing the two lower corners at the same time (see illustration). The hooks at the side will prevent the panel from falling off.
- Now the remove the panel by pulling it diagonally upwards.
- Then place it to one side.

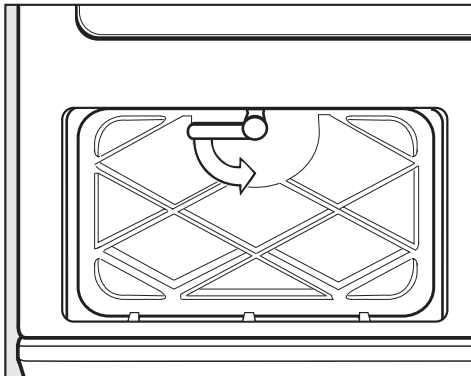

- Turn the lever on the inner cover downwards to the vertical position.
- Pull the cover forwards
- Then remove it by pulling it diagonally upwards.

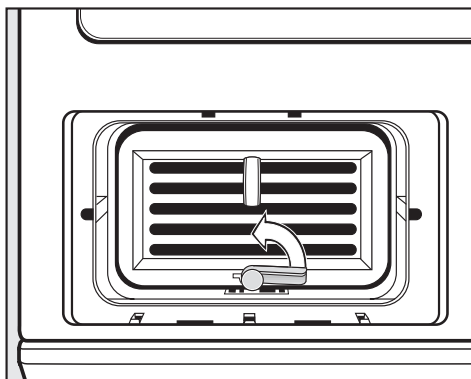

- Turn the lever on the condenser unit to the vertical position.

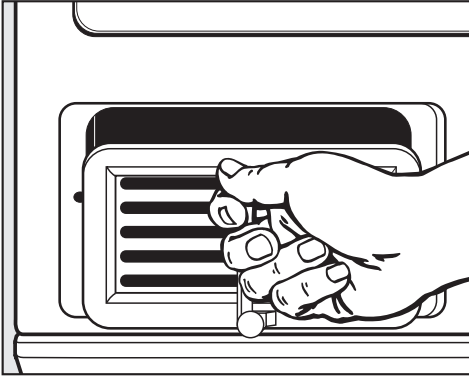

- Pull the condenser unit out of its housing by the handle.

Checking the condenser unit

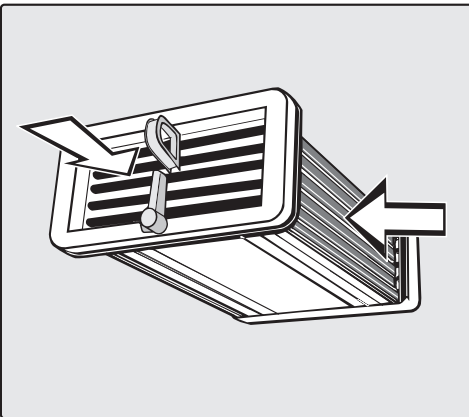

- Hold the condenser unit up to the light.
- Check to see if there is any fluff inside it.
The arrows in the illustration above indicate where to look.

If you cannot see any fluff:

- Replace the condenser unit (see following page).

If you can see some fluff:

- Clean the condenser unit as described below.

Cleaning the condenser unit

- When rinsing the condenser unit, make sure you position it as shown in the next two illustrations.

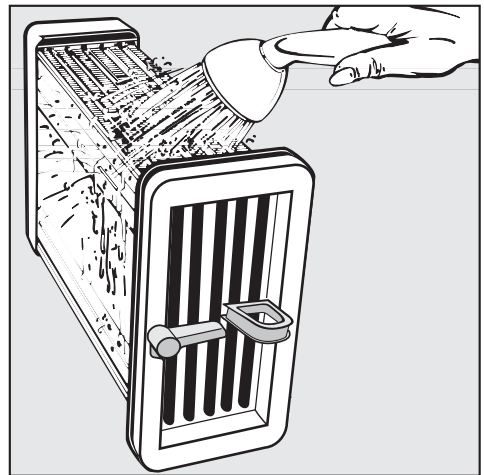

- Use a shower head or similar to rinse the unit out along the left hand side as shown.

Cleaning and care

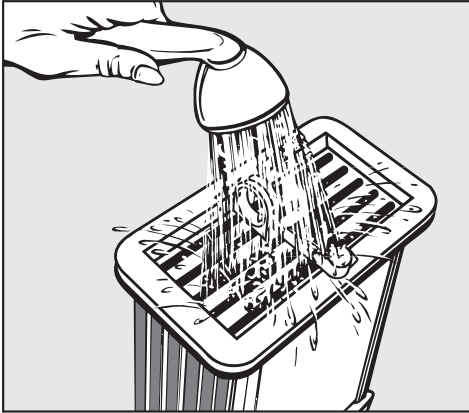

- Then flush the unit through from the front.
- Check the condenser unit again for any visible fluff and if necessary flush it through again until it has all gone.
- Remove any soiling still visible inside the housing unit.
- Also make sure the rubber seals are clean.
The rubber seals must not be removed and must be free of kinks.
- Shake any excess water out of the unit until no more water droplets are visible.

Replacing the condenser unit

- With the handle facing upwards, push the condenser unit back into position in its housing.
- Turn the lever down to the horizontal position, making sure that the hook on the lever clicks into the groove.

When replacing the cover after cleaning, ensure that the rubber seal fits correctly into the groove.

- Replace the cover making sure the hooks locate correctly. Hold it at an angle and push it gently downwards.
- Then turn the lever upwards into the horizontal position to lock the cover.
- Replace the service panel and press the upper edge until it clicks into position.





It is important to ensure that both the condenser unit and the cover are correctly positioned and locked. Otherwise water may leak from the machine.

Problem solving guide



With the help of the following notes, minor faults in the performance of the appliance, some of which may result from incorrect operation, can be put right without contacting the Service Department.

 Repair work to electrical appliances should only be carried out by a suitably qualified person in accordance with local and national safety regulations. Repairs and other work by unqualified persons could be dangerous. The manufacturer cannot be held liable for unauthorised work.

Fault messages in the display

Problem	Possible cause	Remedy
Machine locked Enter lock code	The lock has been activated.	See Settings menu 
 System locked!	The electronic programme lock has been activated.	Press and hold the <i>Start</i> button until Ready! appears in the display.
 ADJUST LOAD! – the programme is cancelled. – the buzzer sounds	This is not a fault. The electronic unit recognises that there is no laundry in the drum and cancels the programme. Drying individual garments or items which are already dry can also cause the programme to be cancelled.	Use the Warm air programme (timed drying) to dry individual items. To delete the fault message: – Open the door or switch the dryer off and then back on again.
 EMPTY OUT CONTAINER! – the programme is cancelled. – the buzzer sounds	The condensed water container is full or there is a kink in the drain hose.	– Empty out the condensed water container or check the drain hose. To delete the fault message: – Switch the dryer off and then back on again.

Problem solving guide

Problem	Possible cause	Remedy
<p>The following message appears after the programme has finished: Clean fluff filters</p>	<p>The dryer is not working efficiently or economically. Possible causes: The fluff filters are clogged with fluff or with detergent residues.</p>	<ul style="list-style-type: none"> – Clean the fluff filters. If they need to be cleaned with water, make sure they are completely dry before replacing them. – See also the notes on the next page under: The drying process goes on too long or even switches off. <p>To delete the fault message:</p> <ul style="list-style-type: none"> – Switch the dryer off and then back on again.
	<p>You can adjust the setting which controls when or if the message <i>Clean fluff filters</i> appears.</p>	<p>See Settings menu , Airways indicator section.</p>
<p> TECHNICAL FAULT!</p> <ul style="list-style-type: none"> – the programme is cancelled. – the buzzer sounds 	<p>No obvious cause. In some circumstances, <i>Clean fluff filters</i> will already have been displayed.</p>	<ul style="list-style-type: none"> – Clean the fluff filters and the condenser unit. <p>To delete the fault message:</p> <ul style="list-style-type: none"> – Switch the dryer off and then back on again.
	<p>There is a fault, if despite doing this, the programme is cancelled and the fault message appears again.</p>	<p>Contact the Miele Service Department.</p>

Other problems		
Problem	Possible cause	Remedy
The drying process goes on too long or even switches off.	In some circumstances the following message also appears: <i>Clean fluff filters</i> Please check all the possible causes and switch the dryer off and then back on again.	
	Ventilation to and from the dryer may be insufficient (e.g because it is installed in a small room). This has caused the temperature in the room to rise sharply.	Open a door or window while the machine is in operation for increased air flow.
	The fluff filters are clogged up with fluff or were still wet when they were replaced.	<ul style="list-style-type: none"> – Remove any fluff. – The fluff filters must be completely dry.
	The laundry has not been spun sufficiently.	Make sure that your laundry is thoroughly spun at the washing machine's maximum spin speed.
	The tumble dryer has been overloaded.	Do not exceed the maximum load for the programme selected.
	Metallic components, e.g. zips have prevented the dryer from registering the correct moisture level in the laundry.	<ul style="list-style-type: none"> – Close zips and fasten any hooks next time. If the problem occurs again, dry garments with long zips using the Warm air programme (timed drying).
	Detergent residues, hair and fine fibres can block up the condenser unit.	Check the condenser unit from time to time and clean it if necessary.
	The vents below the door are blocked.	Remove any objects that are blocking the vents.
The laundry is not sufficiently dry.	The load consisted of different fabrics.	<ul style="list-style-type: none"> – Finish drying using the <i>Warm air</i> programme. – Select the <i>Automatic</i> the next time.

Problem solving guide

Problem	Possible cause	Remedy
The condenser unit service panel will not shut.	The inner cover of the condenser unit has not been locked properly and/or the condenser unit has not been positioned correctly.	<ul style="list-style-type: none"> – Ensure that the condenser unit is positioned correctly and lock the cover. – Check the rubber seals.
Water leaks from the machine after the condenser unit has been cleaned.	Fluff has collected at the bottom of the condenser unit housing.	<ul style="list-style-type: none"> – Use a cloth to remove any fluff from the inside of the condenser unit housing.
Items made of synthetic fibres are charged with static electricity after drying.	Synthetic fibres tend to attract static charge.	Static charge can be reduced by adding a fabric conditioner to the final rinse in the washing machine or a fabric conditioner sheet to the load in the dryer.
There is a build up of fluff.	Fluff is principally the result of friction when garments are being worn and washed. Machine drying hardly causes any fluff to form and, as has been established by research institutes, has no effect on the lifetime of fabric.	Fluff is collected by the fluff filters and can be easily removed (see Cleaning and Care).
There are water droplets at the upper edge of the drum aperture.	A double filter system prevents fluff from being deposited in the condenser unit. This insulation can lead to a build-up of condensation.	Laundry being removed from the machine may come into contact with these water droplets, but they will dry off in a matter of minutes.

Problem solving guide

Problem	Possible cause	Remedy
The programme does not start and the display is dark.	No obvious cause.	<ul style="list-style-type: none"> – Have you followed correct procedure for using the machine? – Is the plug correctly inserted in the socket and switched on? – Is the appliance door closed properly? – Has the fuse or circuit breaker tripped?
The interior drum lighting does not come on.	The lighting switches off automatically (to save energy).	Switch the dryer off and then on again.
	The lamp needs changing.	Change the lamp as described at the end of this section.
The display is in a different language.	A different language has been selected in the Settings - Language  menu.	Set the language you want. The flag symbol will guide you.
The <i>Start</i> button light will flash when a programme is being selected.	This is not a fault.	The flashing indicates that a programme can be started. After the programme has started the flashing will change to a constant light.
The display is dark and the light ring around the multi-function selector is not lit up. The <i>Start</i> button is flashing slowly.	The display has switched off automatically to save energy (Stand-by mode).	The display and the multi-function selector will light up when one of the buttons is pressed.
	The lighting is defective if it does not come on when one of the buttons is pressed.	Contact the Miele Service Department.

Problem solving guide

Changing the lamp

Disconnect the machine from the mains electricity supply.

- Open the door.

You will find the interior lamp cover at the top of the drum aperture.

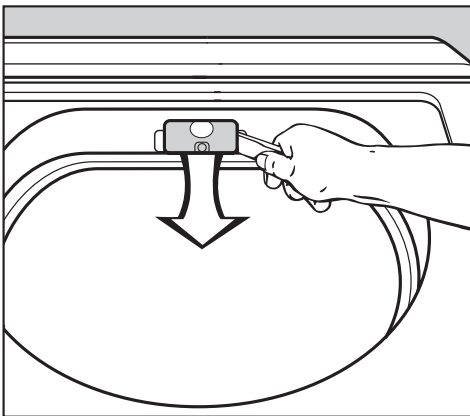

- Insert the opener under the side edge of the cover as illustrated.
- Turn your wrist to make the cover open downwards.

The temperature resistant lamp should only be ordered from your Miele dealer or the Miele Spare Parts Department.

The lamp specification and maximum wattage is stated on the data plate and on the light cover.

- Replace the lamp.

- To close the cover push it upwards and press it on the left and right until you hear it click into position.

⚠ Ensure that it is fitted into position securely, as any moisture could cause a short circuit.

In the event of any faults which you cannot remedy yourself, or if the machine is under guarantee, please contact

- your Miele dealer or
- the Miele Service Department (see back cover for contact details).

When contacting the Service Department, please quote the model and serial number of your appliance, both of which are shown on the data plate situated on the right hand side below the drum aperture.

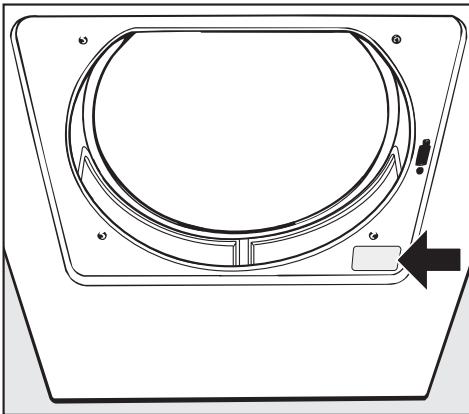

Future updates (PC)

The indicator light marked **PC** is the interface used by Miele service technicians for programming updates into the machine should these become available in the future.

When, for example, new programmes are developed or new fabrics are introduced, a service engineer will be able to modify existing programme cycles accordingly.

Miele will provide information when such developments become available.

Optional accessories

Optional accessories for these dryers are available from your Miele Dealer or from the Miele Spare Parts Department.

Please note that telephone calls may be monitored and recorded to improve our service.

Installation

Front view

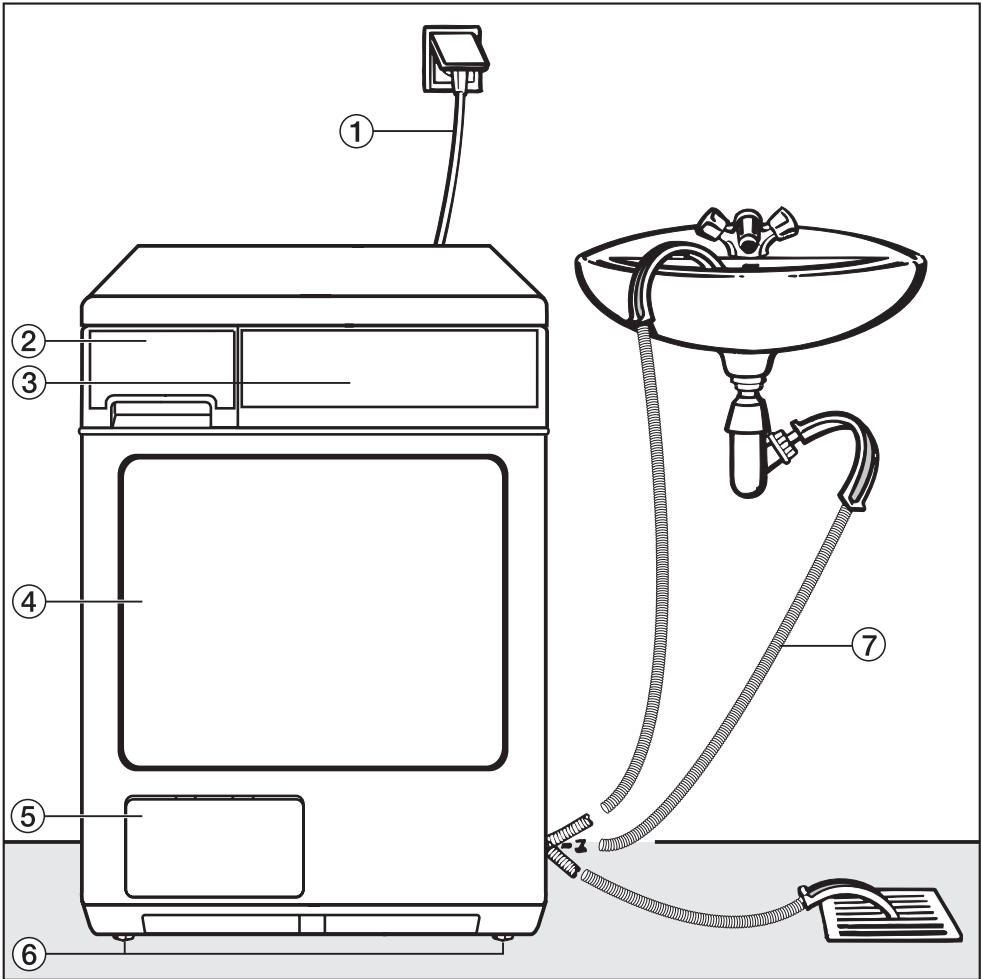

- ① Supply cable for electrical connection
- ② Condensed water container
- ③ Control panel
- ④ Door
- ⑤ Service panel for condenser unit
- ⑥ Four height-adjustable screw feet
- ⑦ External drainage options (e.g. via wash basin, wash basin drain outlet, or gully).

Installation site

 Make sure the dryer door can be opened without hindrance after installation.

Transporting the machine to its installation site

When moving the machine you can hold it by the lid where it protrudes to the rear of the dryer.

To manoeuvre the dryer out of its packing case to its installation site you will also need to hold it by the front feet.

Building under a continuous worktop / in a row of kitchen units

The dryer should not be installed next to a refrigerator or freezer. The warm air expelled from the rear of the dryer would increase the temperature around the refrigerator's/freezer's heat exchanger causing the compressor to run continuously.

If it is not possible to install the dryer anywhere else, then the refrigerator/freezer must be sealed off from the dryer.

A **building under kit*** is required. The machine lid is replaced by a coverplate which must be fitted by a suitably qualified person to ensure electrical safety.

- When installing under a 900/910 mm high worktop a spacer kit* is required.
- The electrical socket must be located in an accessible position near the machine.

* Available as an optional accessory from your Miele dealer or the Miele Spare Parts Department.

The building under kit is supplied with its own installation instructions.

When built under running times may be longer.

Replacing the lid

If the lid has been removed in order to fit a cover plate, ensure that, if the lid is replaced, it fits securely into the rear holders. Otherwise, it is not properly secure for transport.

Installation

Aligning the machine

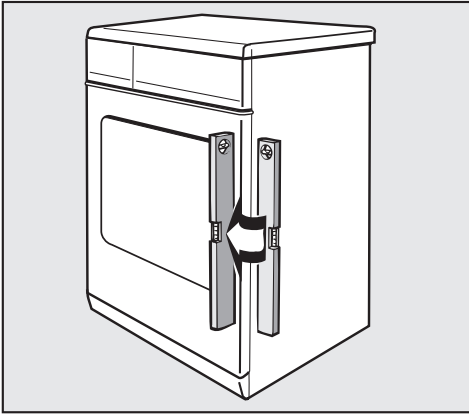

The machine must be perfectly level to ensure safe and proper operation.

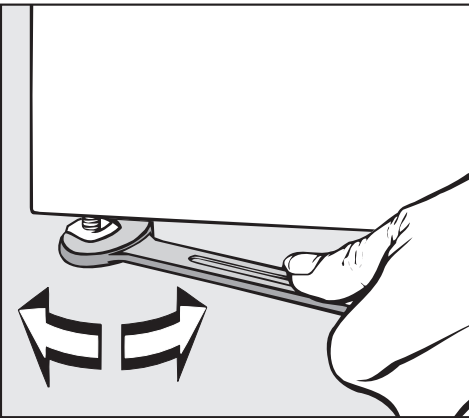

- The screw feet can be adjusted to compensate for any unevenness in the floor.

 The ventilation gaps in the plinth must not be covered over as this would prevent a sufficient intake of air.

Room in which the dryer is located

Air taken in for use in the drying process will be warm when it is expelled from the rear of the dryer. This expelled air heats up the air in the room. It is therefore very important to ensure that the room is adequately ventilated, particularly if the dryer is located in a small room. Otherwise running times and energy consumption could be increased.

Washer - dryer stack

The tumble dryer can also be combined with a Miele washing machine in a washer-dryer stack. To do this the appropriate stacking kit* (WTV) to match your washing machine is required.

* Available as an optional accessory from your Miele dealer or the Miele Spare Parts Department. Stacking kits must be fitted by a suitably qualified fitter.

Before moving the machine again (e.g. when moving house)

After each use a small quantity of condensed water will collect in the area around the pump. This water can run out if the machine is tipped up when it is being moved. It is a good idea to run the *Cool air* programme for approximately 1 minute before moving the machine. Any remaining condensed water will then be fed into the condensed water container or out through the drain hose.

External condensed water outlet

When drying is in progress, condensed water is pumped into the condensed water container through the drain hose at the back of the dryer. The condensed water can also be drained off directly if the machine is installed near a sink, drain outlet etc. so that the condensed water container does not have to be emptied.

The drain hose (approx. 2 m long) is stored in the dryer. It must be pulled out of the dryer to its full extent if condensed water is to be drained externally.

Maximum delivery head: 1 m.

If it is not long enough, an extension hose is available as an optional accessory through your dealer or from the Miele Spare Parts Dept.

Pulling out the drain hose

From the back of the dryer at the top:

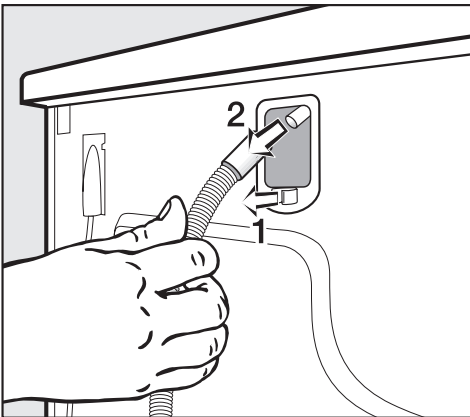

- Unclip the drain hose (1).
- Then pull it off holder (2).

From the back of the dryer at the bottom:

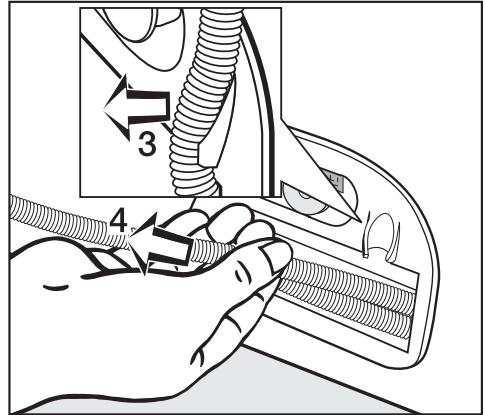

- Unclip the drain hose from holder (3).
- Then pull the drain hose **completely out of the dryer towards the left** (4) (See illustration).

⚠ Important: do not let the drain hose become kinked as this could damage it.

⚠ If you want to drain the water off into a sink you will need to secure the hose carefully, e.g. by tying it to a tap to make sure it cannot slip during use. Otherwise there is a risk of overflowing water which could cause damage.

Use the bow-shaped guide to prevent the drain hose from becoming kinked (see "Front view" illustration).

Installation

Connection to a sink drain outlet

The drain hose can be connected directly to a sink drain outlet.

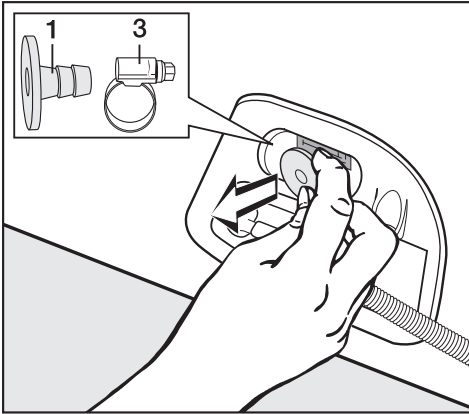

- Remove the following from the back of the dryer at the bottom:
Adapter **1** and hose clip **3** behind it.

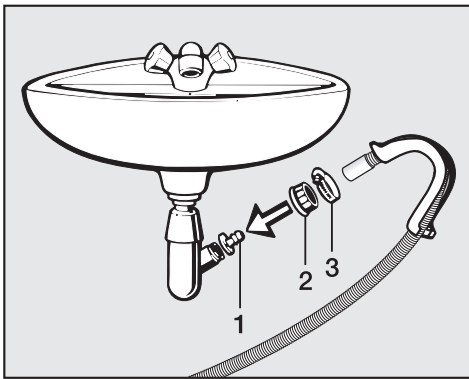

- Fit adapter **1** to the sink drain outlet using nut **2**.

If this nut has a flat disc sealing it you should take the disc out first.
Important: if this nut has a washer or seal in it this must not be removed!

- Attach the end of the hose to adapter **1**.
- Use a screwdriver to tighten hose clip **3** up close to the nut.

If you no longer wish to use an external condensed water outlet:

⚠ Do not push the drain hose back into the dryer. Doing this could cause it to become kinked and damaged in the dryer.

- Loop the drain hose up.
- Use a suitable cable tie to secure the looped hose to the back of the dryer, or simply lay the looped hose behind the dryer.
- Attach the open end of the drain hose back onto the holder at the back of the dryer at the top (see holder **2** in "Pulling out the drain hose").

Electrical connection U.K.

All electrical work should be carried out only by a suitably qualified and competent person, in strict accordance with national and local safety regulations.

Ensure power is not supplied to the appliance while installation work is being carried out.

The appliance is supplied with a mains cable with moulded plug for connection to a 230-240V mains supply. **The voltage, rated load and fuse rating are given on the data plate.** Please ensure these match the household mains supply.

Connection should be made via a fused plug and suitable switched socket which is easily accessible after installation.

For extra safety it is advisable to install a residual current device (RCD), with a trip current of 30 mA (in accordance with DIN VDE 0664, VDE 0100, section 739).

Do not connect via an extension lead.

Important

The wires in the mains lead are coloured in accordance with the following code:

Green/yellow = earth

Blue = neutral

Brown = live

Electrical connection U.K. Non-rewireable plugs BS 1363

If this machine is fitted with a non-rewireable plug and the socket outlets are not suitable for the plug supplied or if the existing plug needs to be replaced by a new one, the old plug will need to be cut off and an appropriate plug fitted. The fuse carrier and the fuse should be removed from the old plug and disposed of.

The plug cut from the cable should then be disposed of and on no account be inserted into any socket elsewhere in the house (electric shock hazard).

The fuse cover must be refitted when changing the fuse, and if the fuse cover is lost, the plug must not be used until a suitable replacement is obtained. The colour of the correct replacement cover is that of the coloured insert in the base of the plug, or the colour that is embossed in words on the base of the plug (as applicable to the design of plug fitted).

Replacement fuses should be ASTA approved to BS 1362 and have the correct rating. Replacement fuses and fuse covers may be purchased from your local electrical supplier or Service agent.

Electrical connection

If the colours of the wires in the mains lead of this appliance do not correspond with the coloured markings identifying the terminals of your plug, proceed as follows:

- The wire which is coloured green and yellow must be connected to the terminal in the plug which is marked with the letter E or by the earth symbol \perp or coloured green, or green and yellow.
- The wire which is coloured blue must be connected to the terminal in the plug which is marked with the letter N or coloured black.
- The wire which is coloured brown must be connected to the terminal in the plug which is marked with the letter L or coloured red.

**WARNING: THIS APPLIANCE
MUST BE EARTHED**

Consumption data

Programme	Max. load	Final spin speed in a washing machine	Energy	Time
<i>EN 61121 test programme:</i>				
Cottons Normal	5.0 kg	800 rpm	3.40 kWh	89 mins
Cottons Hand iron ΔΔ		(70 % residual moisture)		
Cottons Hand iron ΔΔ	5.0 kg	800 rpm	2.70 kWh	74 mins
Minimum iron Normal		(70 % residual moisture)		
Minimum iron Normal	2.5 kg	1000 rpm	1.25 kWh	38 mins
		(50 % residual moisture)		
Cottons Extra dry	5.0 kg	1200 rpm	3.25 kWh	84 mins
		1400 rpm	3.10 kWh	81 mins
		1600 rpm	2.85 kWh	74 mins
		1800 rpm	2.80 kWh	73 mins
Cottons Normal +	5.0 kg	1200 rpm	2.80 kWh	75 mins
		1400 rpm	2.65 kWh	71 mins
		1600 rpm	2.40 kWh	65 mins
		1800 rpm	2.35 kWh	64 mins
Cottons Normal	5.0 kg	1200 rpm	2.65 kWh	72 mins
		1400 rpm	2.55 kWh	68 mins
		1600 rpm	2.25 kWh	62 mins
		1800 rpm	2.20 kWh	61 mins
Cottons Hand iron Δ	5.0 kg	1200 rpm	2.20 kWh	62 mins
		1400 rpm	2.05 kWh	59 mins
		1600 rpm	1.80 kWh	52 mins
		1800 rpm	1.75 kWh	51 mins
Cottons Hand iron ΔΔ	5.0 kg	1200 rpm	2.00 kWh	57 mins
		1400 rpm	1.85 kWh	53 mins
		1600 rpm	1.60 kWh	47 mins
		1800 rpm	1.55 kWh	46 mins
Cottons Machine iron	5.0 kg	1200 rpm	1.60 kWh	47 mins
		1400 rpm	1.45 kWh	44 mins
		1600 rpm	1.20 kWh	37 mins
		1800 rpm	1.15 kWh	36 mins
Minimum iron Hand iron Δ	2.5 kg	1000 rpm	1.10 kWh	35 mins
Woolens handcare	2.0 kg	-	0.20 kWh	4 mins
Smoothing	2.5 kg	-	0.30 kWh	8 mins
Denim	2.0 kg	900 rpm	1.20 kWh	45 mins
Shirts	1.5 kg	600 rpm	1.25 kWh	39 mins
Outer wear	2.0 kg	800 rpm	1.70 kWh	74 mins
Automatic Normal	3.0 kg	900 rpm	1.90 kWh	55 mins

All data established in accordance with EN 61121

Before testing in accordance with EN 61121, dry a 3 kg load of cotton laundry with 70% residual moisture as per the above standard using the Cottons Normal programme without selecting any Extra options.

Consumption data can vary from the nominal values given above depending on the size of the load, types of textiles, residual moisture levels after spinning, fluctuations in the electricity supply and any Extra options selected.

Technical data

Height	85 cm (adjustable +0.7/- 0.7 cm)
Height without lid	82 cm
Width	59.5 cm
Depth	58 cm
Weight	54 kg
Drum volume	100 litres
Maximum capacity	5 kg dry weight
Capacity of condensed water container	approx. 3.5 litres
Length of connection cable	1.60 m
Maximum delivery head	1 m
Maximum drain hose length	3 m
Voltage	see data plate
Rated load	see data plate
Fuse rating	see data plate
Lamp wattage	see data plate
Energy consumption	see "Consumption data"
Test certificates awarded	Radio/TV suppressed, VDE

Settings menu for changing standard settings

The Settings menu is used to alter the dryer's electronics to suit different requirements.
Settings can be altered at any time.

Settings menu

Open the *Settings* menu



- Select *Settings*  from the entry menu and confirm your selection with the multi-function selector.

Select *Settings*



- Select the setting you want to change and confirm your selection.

If you do not make a selection in the sub-menu within approx. 20 seconds, the display will revert to the main menu.

Language

The display shows several different languages.

You can select one of the languages displayed via the *Languages*  sub-menu.

The flag after the word *Languages* acts as a guide to prevent a language which will not be understood from being set.

A tick will appear beside the language to show that it has been set.

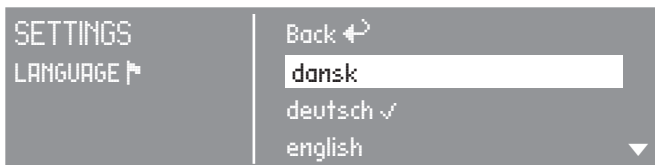

Select the language you want and confirm your selection.

Time of day

First select either a 24 hour or 12 hour clock.
Then set the current time of day.

To select a 24 hour or 12 hour clock

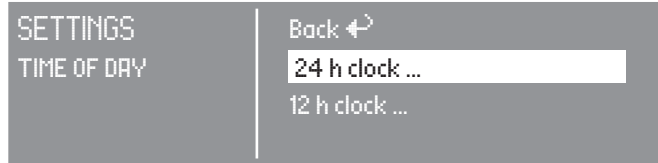

- Select the clock option you want and confirm your selection.

The display will then switch to the time of day setting.

To set the time of day

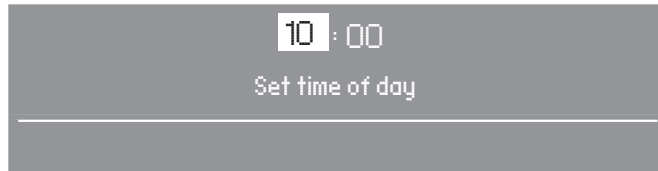

- Use the multi-function selector to select the hour and confirm your selection. Now set the minutes. Confirm the selection again to save the time of day in memory.

The time of day can be changed at any time later on by:

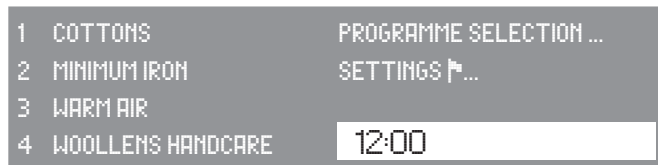

- Highlighting the time of day in the Entry menu and confirming your selection.

The display will then change to the time of day setting.

Settings menu

Drying levels

You can alter the drying levels for the *Cottons* and *Minimum iron* programmes.



- Select a programme and confirm your selection. The bar chart shows you the setting. The machine is delivered with a medium setting set as standard.



- Select the drying level you want and confirm your selection.
 - The programme duration will be shorter (Damper) or longer (Drier).

Extending the cooling down time

The Cooling down phase which takes place before the end of a programme can also be lengthened if required. This makes the garments easier to handle.

The bar chart shows you the setting. The machine is delivered with: 0 mins (normal cooling down period) set as standard.

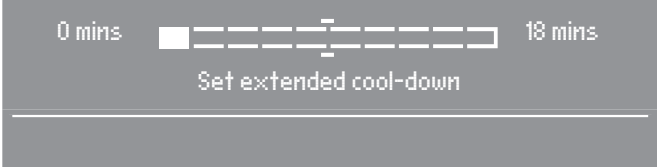

- Select the extended time you want (in 2 minute increments) and confirm your selection.
 - The programme duration will increase accordingly.
 - You cannot extend the Cooling down time for the *Warm air*, *Cool air*, *Woollens handcare*, *Smoothing* programmes.

Airways indicator

Fluff should be removed after drying. The *Clean fluff filters* indicator will remind you to clean the filters when a certain amount of fluff has collected in the filters. You can decide at what level of fluff this reminder should be given.

You will have an idea of how often this should be done after a few drying programmes.

- Off = *Clean fluff filters* does not appear
- Non-sensitive = *Clean fluff filters* only appears when there is a heavy build-up of fluff
- Normal = Factory default setting
- Sensitive = *Clean fluff filters* appears when there is only a small build-up of fluff

A tick will appear beside the option to show that it has been set.



- Select the option you want and confirm your selection.

Anti-crease

The drum will continue to rotate at intervals for one hour to prevent laundry creasing, if you do not wish to remove it immediately.

A tick will appear beside the option to show that it has been set.

The machine is delivered with this option set to: on.

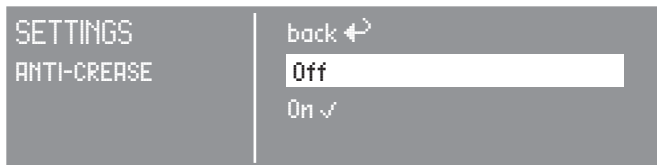

- Select the option you want and confirm your selection.

Settings menu

Lock

The system lock prevents your machine being used without your knowledge.

When the system lock has been activated, you have to enter a code after switching the dryer on. Otherwise the dryer cannot be operated.

To activate the lock

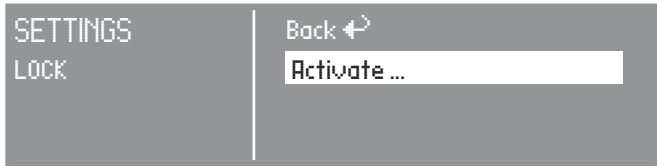

- Select *Activate* and confirm your selection.

To enter the lock code

The display will now request that a code is entered. The code is **250** and cannot be altered.



- Turn the multi-function selector until the number **2** appears. Confirm your selection of this number. Now set the second number.
- Repeat the process until all three numbers have been entered.

After the last number has been entered, you must confirm the code with OK.



- Confirm the code.

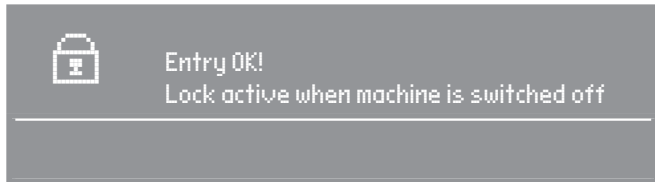

- Switch off the dryer.

To unlock the machine

When the machine is switched on again, the display will request the lock code.

- Enter lock code **250** as described above and confirm the entry.

To deactivate the lock

Proceed as for activating the lock.

Settings menu

Buzzer

A buzzer sounds to let you know the programme has finished.

Off = The buzzer is switched off but sounds at maximum volume if there is a fault.

Normal = The buzzer sounds at the end of a programme.

Loud = The buzzer sounds louder at the end of a programme.

The buzzer will sound briefly when the option *Normal* or *Loud* has been selected.

A tick will appear beside the option to show that it has been set.

The machine is delivered with the option: Normal set as standard.

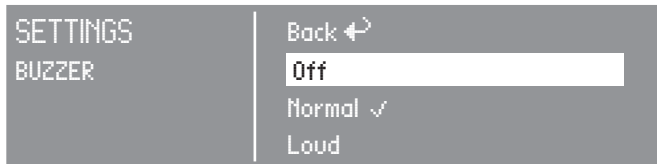

■ Select the option you want and confirm your selection.

Keypad tones

An audible tone sounds when the *Start* button, a short cut button or the multi-function selector is pressed.

A tick will appear beside the option to show that it has been set.

The machine is delivered with the option: Off set as standard.

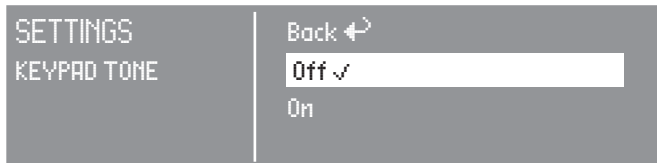

■ Select the option you want and confirm your selection.

Display contrast

There are ten different display contrast settings.

The display contrast will change as soon as a different setting is chosen.

The bar chart shows you the setting.

The machine is delivered with a medium setting set as standard.



- Set the display contrast you require.

Settings menu

Stand-by

To save energy, the display goes out after 10 minutes and the *Start* button flashes slowly.

There are two options:

on (the machine is delivered with this option selected)

Stand-by comes on:

- if a programme is not selected after the machine has been switched on.
- after the *Start* button has been pressed.
- at the end of a programme.

Not in current prog.

Stand-by comes on:

- if a programme is not selected after the machine has been switched on.

Operating the multi-function selector or one of the short cut buttons switches the display back on again.

A tick will appear beside the option to show that it has been set.

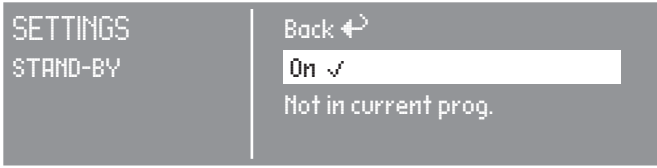

- Select the option you want and confirm your selection.

To close the *Settings* menu

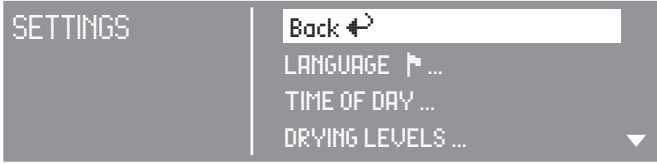

- Select *Back* and confirm your selection. The display will revert to the entry menu.

United Kingdom:

Miele Co. Ltd.
Fairacres, Marcham Road
Abingdon, Oxon, OX14 1TW
tel. Abingdon (01235) 554455
Service Office: (01235) 554466
fax (01235) 554477
Internet: www.miele.co.uk

Ireland:

Miele Ireland Ltd.
Broomhill Road, Tallaght, Dublin 24
Tel: (01) 46 10 710, Fax: (01) 46 10 797
Email: info@miele.ie
Internet: <http://www.miele.ie>

Australia:

Miele Australia Pty. Ltd.
A.C.N. 005635398
1 Gilbert Park Drive
Knoxfield, VIC 3180
Telephone: (03) 9764 7100
Fax: (03) 9764 7129
Internet: www.miele.com.au

Distributor New Zealand:

Steelfort Engineering Company. Ltd.
500 Rangitikei Street
Palmerston North, Priv. Bag 11045, NZ
Telephone: (06) 350 1350
Fax: (06) 356 1507

South Africa:

Miele (Pty) Ltd
304 Tungsten Road
Strijdom Park 2194
P.O.Box 1654, Randburg 2125
Tel. (011) 793-7452
Telefax (011) 793-7447
E-mail: info@miele.co.za
Internet: www.miele.co.za

Singapore:

Miele Southeast Asia
Miele Pte. Ltd.
163 Penang Road
04 - 02/03 Winsland House II
Singapore 238463
Tel : +65-67351191
Fax: +65-67351161
Email: mielesea@miele.com.sg

Hong Kong:

Miele (Hong Kong) Limited
AIA Plaza, Room 401, 4th Floor
18 Hysan Avenue
Causeway Bay
Hong Kong
Tel.: (852) 2610 1331
Fax: (852) 2610 1013
E-mail: mielehk@netnavigator.com